

# Dimension Guide

## Fixed speed air conditioner

**Models:**  
ES30K11BCCI

Dimensions			
	width	height	depth
Product (mm)	1259	362	282

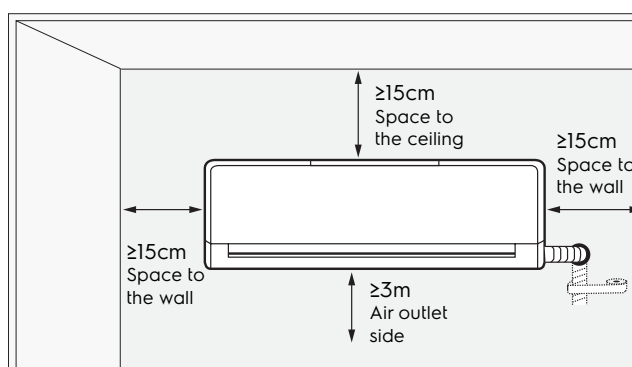
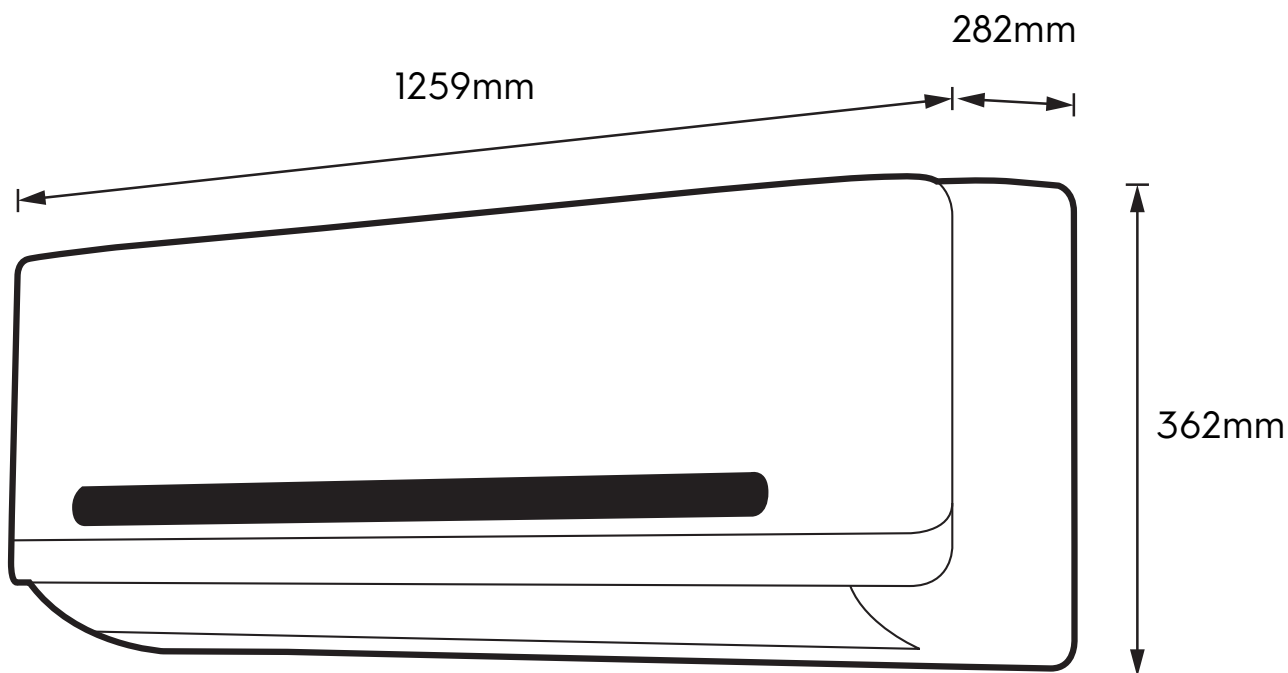

**Please note!** Dimensions to be used as a guide only. All customers MUST refer to the user manual supplied with the product for detailed installation instructions.

© 2022 Electrolux S.E.A PTE. LTD. E\_DIM\_ES30K11BCCI\_Aug22