

Dimension Guide

Fixed speed air conditioner

Models:
ES24K31BCCI

Dimensions			
	width	height	depth
Product (mm)	1082	337	234

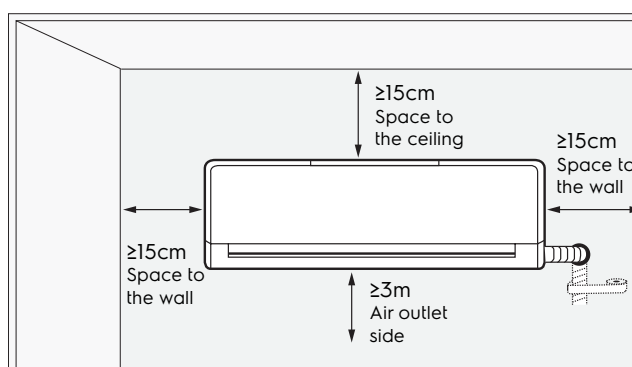
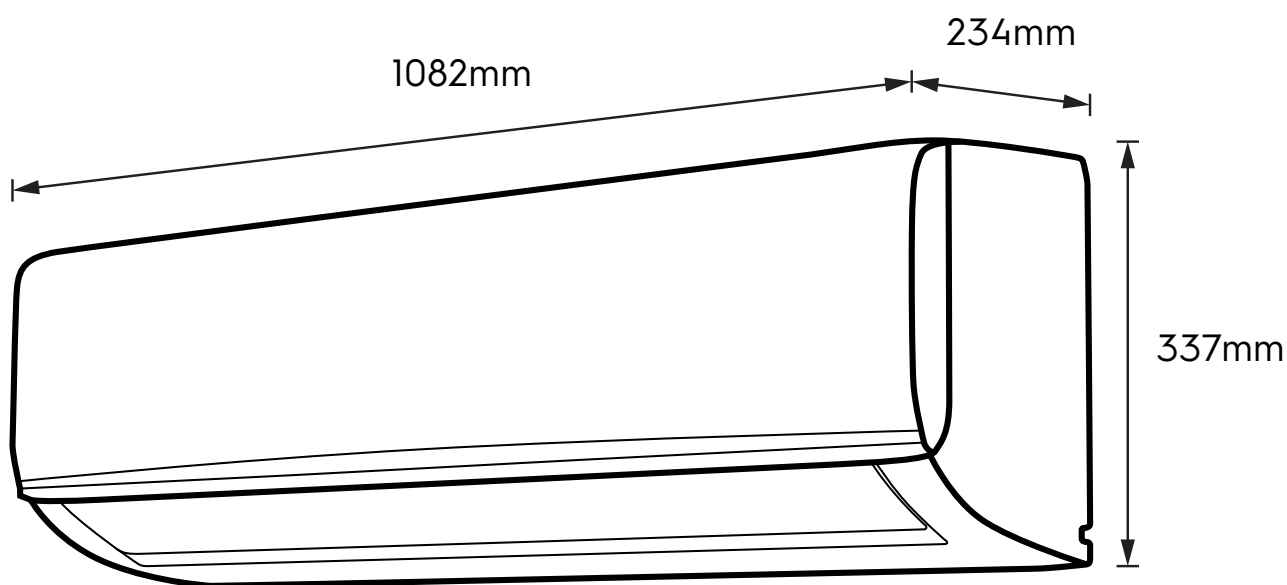

Please note! Dimensions to be used as a guide only. All customers MUST refer to the user manual supplied with the product for detailed installation instructions.

© 2022 Electrolux S.E.A PTE. LTD. E_DIM_ES24K31BCCI_Aug22