

LKR620002W
LKR620002X



EN Cooker

User Manual

CONTENTS

1. SAFETY INFORMATION.....	3
2. SAFETY INSTRUCTIONS.....	5
3. INSTALLATION.....	7
4. PRODUCT DESCRIPTION.....	10
5. BEFORE FIRST USE.....	10
6. HOB - DAILY USE.....	11
7. HOB - HINTS AND TIPS.....	12
8. HOB - CARE AND CLEANING.....	13
9. OVEN - DAILY USE.....	14
10. OVEN - CLOCK FUNCTIONS.....	15
11. OVEN - USING THE ACCESSORIES.....	15
12. OVEN - HINTS AND TIPS.....	16
13. OVEN - CARE AND CLEANING.....	22
14. TROUBLESHOOTING.....	24
15. ENERGY EFFICIENCY.....	25
16. SAUDI ARABIA - CUSTOMER SERVICE.....	26
17. ENVIRONMENTAL CONCERNS.....	27

WE'RE THINKING OF YOU

Thank you for purchasing an Electrolux appliance. You've chosen a product that brings with it decades of professional experience and innovation. Ingenious and stylish, it has been designed with you in mind. So whenever you use it, you can be safe in the knowledge that you'll get great results every time.

Welcome to Electrolux.

Visit our website to:



Get usage advice, brochures, trouble shooter, service and repair information:

www.electrolux.com/support



Register your product for better service:

www.registerelectrolux.com



Buy Accessories, Consumables and Original spare parts for your appliance:

www.electrolux.com/shop

CUSTOMER CARE AND SERVICE

Always use original spare parts.

When contacting our Authorised Service Centre, ensure that you have the following data available: Model, PNC, Serial Number.

The information can be found on the rating plate.

 Warning / Caution-Safety information

 General information and tips

 Environmental information

Subject to change without notice.

1. ⚠ SAFETY INFORMATION

Before the installation and use of the appliance, carefully read the supplied instructions. The manufacturer is not responsible for any injuries or damage that are the result of incorrect installation or usage. Always keep the instructions in a safe and accessible location for future reference.

1.1 Children and vulnerable people safety

- This appliance can be used by children aged from 8 years and above and persons with reduced physical, sensory or mental capabilities or lack of experience and knowledge if they have been given supervision or instruction concerning the use of the appliance in a safe way and understand the hazards involved. Children of less than 8 years of age and persons with very extensive and complex disabilities shall be kept away from the appliance unless continuously supervised.
- Children should be supervised to ensure that they do not play with the appliance.
- Keep all packaging away from children and dispose of it appropriately.
- **WARNING:** Keep children and pets away from the appliance when it operates or when it cools down. Accessible parts become hot during use.
- Children shall not carry out cleaning and user maintenance of the appliance without supervision.

1.2 General Safety

- Only a qualified person must install this appliance and replace the cable.
- This appliance must be connected to the mains with a H05VV-F type cable to withstand the temperature of the rear panel.
- This appliance is intended for use up to an altitude of 2000 m above sea level.

- This appliance is not intended to be used on ships, boats or vessels.
- Do not install the appliance behind a decorative door in order to avoid overheating.
- Do not install the appliance on a platform.
- Do not operate the appliance by means of an external timer or separate remote-control system.
- **WARNING:** Unattended cooking on a hob with fat or oil can be dangerous and may result in fire.
- Never use water to extinguish the cooking fire. Switch off the appliance and cover flames with e.g. a fire blanket or lid.
- **CAUTION:** The cooking process has to be supervised. A short term cooking process has to be supervised continuously.
- **WARNING:** Danger of fire: Do not store items on the cooking surfaces.
- Do not use a steam cleaner to clean the appliance.
- Do not use harsh abrasive cleaners or sharp metal scrapers to clean the glass door or the glass of hinged lids of the hob since they can scratch the surface, which may result in shattering of the glass.
- Metallic objects such as knives, forks, spoons and lids should not be placed on the hob surface since they can get hot.
- If the glass ceramic surface / glass surface is cracked, switch off the appliance and unplug it from the mains. In case the appliance is connected to the mains directly using junction box, remove the fuse to disconnect the appliance from power supply. In either case contact the Authorised Service Centre.
- **WARNING:** The appliance and its accessible parts become hot during use. Care should be taken to avoid touching heating elements.
- Always use oven gloves to remove or insert accessories or ovenware.
- Before maintenance, cut the power supply.

- **WARNING:** Ensure that the appliance is switched off before replacing the lamp to avoid the possibility of electric shock.
- If the mains power supply cable is damaged, it must be replaced by the manufacturer, its Authorised Service Centre or similarly qualified persons to avoid an electrical hazard.
- Be careful when you touch the storage drawer. It can get hot.
- The means for disconnection must be incorporated in the fixed wiring in accordance with the wiring rules.
- **WARNING:** Use only hob guards designed by the manufacturer of the cooking appliance or indicated by the manufacturer of the appliance in the instructions for use as suitable or hob guards incorporated in the appliance. The use of inappropriate guards can cause accidents.

2. SAFETY INSTRUCTIONS

2.1 Installation



WARNING!

Only a qualified person must install this appliance.

- Remove all the packaging.
- Do not install or use a damaged appliance.
- Follow the installation instructions supplied with the appliance.
- Always take care when moving the appliance as it is heavy. Always use safety gloves and enclosed footwear.
- Do not pull the appliance by the handle.
- The kitchen cabinet and the recess must have suitable dimensions.
- Keep the minimum distance from other appliances and units.
- Install the appliance in a safe and suitable place that meets installation requirements.
- Parts of the appliance carry current. Close the appliance with furniture to prevent touching the dangerous parts.

- The sides of the appliance must stay next to appliances or units with the same height.
- Do not install the appliance adjacent to a door or under a window. This prevents hot cookware to fall from the appliance when the door or the window is opened.
- Make sure to install a stabilizing means in order to prevent tipping of the appliance. Refer to Installation chapter.

2.2 Electrical Connection



WARNING!

Risk of fire and electric shock.

- All electrical connections should be made by a qualified electrician.
- The appliance must be earthed.
- Make sure that the parameters on the rating plate are compatible with the electrical ratings of the mains power supply.
- Always use a correctly installed shockproof socket.

- Do not use multi-plug adapters and extension cables.
- Do not let mains cables touch or come near the appliance door or the niche below the appliance, especially when it operates or the door is hot.
- The shock protection of live and insulated parts must be fastened in such a way that it cannot be removed without tools.
- Connect the mains plug to the mains socket only at the end of the installation. Make sure that there is access to the mains plug after the installation.
- If the mains socket is loose, do not connect the mains plug.
- Do not pull the mains cable to disconnect the appliance. Always pull the mains plug.
- Use only correct isolation devices: line protecting cut-outs, fuses (screw type fuses removed from the holder), earth leakage trips and contactors.
- The electrical installation must have an isolation device which lets you disconnect the appliance from the mains at all poles. The isolation device must have a contact opening width of minimum 3 mm.
- Fully close the appliance door before you connect the mains plug to the mains socket.

2.3 Use



WARNING!

Risk of injury and burns.
Risk of electrical shock.

- This appliance is for household (indoors) use only.
- Do not change the specification of this appliance.
- Make sure that the ventilation openings are not blocked.
- Do not let the appliance stay unattended during operation.
- Deactivate the appliance after each use.
- Be careful when you open the appliance door while the appliance is in operation. Hot air can release.
- Do not operate the appliance with wet hands or when it has contact with water.

- Do not use the appliance as a work surface or as a storage surface.



WARNING!

Risk of fire and explosion

- Fats and oil when heated can release flammable vapours. Keep flames or heated objects away from fats and oils when you cook with them.
- The vapours that very hot oil releases can cause spontaneous combustion.
- Used oil, that can contain food remnants, can cause fire at a lower temperature than oil used for the first time.
- Do not put flammable products or items that are wet with flammable products in, near or on the appliance.
- Do not let sparks or open flames to come in contact with the appliance when you open the door.
- Open the appliance door carefully. The use of ingredients with alcohol can cause a mixture of alcohol and air.



WARNING!

Risk of damage to the appliance.

- To prevent damage or discoloration to the enamel:
 - do not put ovenware or other objects in the appliance directly on the bottom.
 - do not put aluminium foil on the appliance or directly on the bottom of cavity.
 - do not put water directly into the hot appliance.
 - do not keep moist dishes and food in the appliance after you finish the cooking.
 - be careful when you remove or install the accessories.
- Discoloration of the enamel or stainless steel has no effect on the performance of the appliance.
- Use a deep pan for moist cakes. Fruit juices cause stains that can be permanent.
- Do not keep hot cookware on the control panel.
- Do not let cookware boil dry.

- Be careful not to let objects or cookware fall on the appliance. The surface can be damaged.
- Do not activate the cooking zones with empty cookware or without cookware.
- Cookware made of cast iron, aluminium or with a damaged bottom can cause scratches. Always lift these objects up when you have to move them on the cooking surface.
- This appliance is for cooking purposes only. It must not be used for other purposes, for example room heating.

2.4 Care and Cleaning



WARNING!

Risk of injury, fire, or damage to the appliance.

- Before maintenance, deactivate the appliance. Disconnect the mains plug from the mains socket.
- Make sure the appliance is cold. There is the risk that the glass panels can break.
- Replace immediately the door glass panels when they are damaged. Contact the Authorised Service Centre.
- Be careful when you remove the door from the appliance. The door is heavy!
- Fat and food remaining in the appliance can cause fire.
- Clean regularly the appliance to prevent the deterioration of the surface material.
- Clean the appliance with a moist soft cloth. Use only neutral detergents. Do not use abrasive products, abrasive cleaning pads, solvents or metal objects.
- If you use an oven spray, follow the safety instructions on the packaging.

- Do not clean the catalytic enamel (if applicable) with any kind of detergent.

2.5 Internal lighting



WARNING!

Risk of electric shock.

- Concerning the lamp(s) inside this product and spare part lamps sold separately: These lamps are intended to withstand extreme physical conditions in household appliances, such as temperature, vibration, humidity, or are intended to signal information about the operational status of the appliance. They are not intended to be used in other applications and are not suitable for household room illumination.
- This product contains a light source of energy efficiency class G.
- Use only lamps with the same specifications.

2.6 Service

- To repair the appliance contact the Authorised Service Centre.
- Use original spare parts only.

2.7 Disposal



WARNING!

Risk of injury or suffocation.

- Contact your municipal authority for information on how to dispose of the appliance.
- Disconnect the appliance from the mains supply.
- Cut off the mains electrical cable close to the appliance and dispose of it.
- Remove the door catch to prevent children or pets from becoming trapped in the appliance.

3. INSTALLATION



WARNING!

Refer to Safety chapters.

3.1 Location of the appliance

You can install your freestanding appliance with cabinets on one or two sides and in the corner.

For minimal distances for fitting check the table.

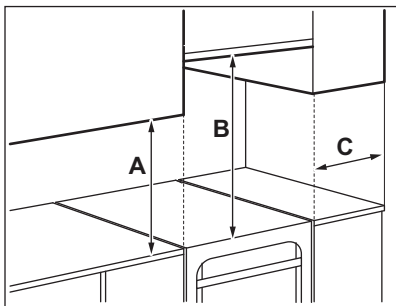

Minimum distances

Dimension	mm
A	400
B	650
C	150

3.2 Technical data

Voltage	230 V
Frequency	50 - 60 Hz
Appliance class	1

Dimension	mm
Height	858
Width	600
Depth	600

3.3 Levelling of the appliance

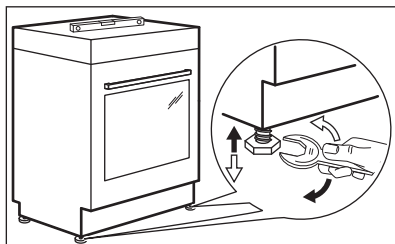

Use small feet on the bottom of appliance to set the appliance top surface level with other surfaces.

3.4 Anti-tilt protection

Set the correct height and area for the appliance before you attach the anti-tilt protection.



CAUTION!

Make sure you install the anti-tilt protection at the correct height.



Make sure that the surface behind the appliance is smooth.

You must install the anti-tilt protection. If you do not install it, the appliance can tilt.

Your appliance has the symbol shown on the picture (if applicable) to remind you about the installation of the anti-tilt protection.

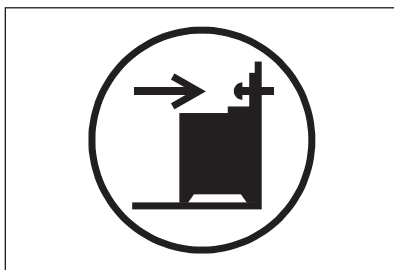

1. Install the anti-tilt protection 232 - 237 mm down from the top surface of the appliance and 110 - 115 mm from the side of the appliance into the circular hole on a bracket. Screw it into the solid material or use applicable reinforcement (wall).

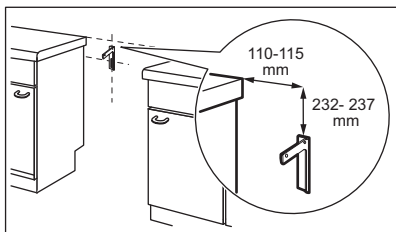

2. You can find the hole on the left side at the back of the appliance. Lift the front of the appliance and put it in the middle of the space between the cupboards. If the space between the bench cupboards is larger than the width of the appliance, you must adjust the side measurement to centre the appliance.

i If you changed the dimensions of the cooker, you must align the non-tip device correctly.

! **CAUTION!**
If the space between the bench cupboards is larger than the width of the appliance, you must adjust the side measurement to the centre of the appliance.

3.5 Electrical installation

! **WARNING!**
The manufacturer is not responsible if you do not follow the safety precautions from Safety chapters.

This appliance is supplied without a main plug or a main cable.

! **WARNING!**
Before you connect the mains cable to the terminal, measure the voltage between phases in the house network. Then, refer to the connection label at the back of the appliance to use the correct electrical installation. This order of steps prevents from installation errors and damage to the electrical components of the appliance.

Applicable types of cables for different phases:

Phase	Min. size cable
1	3x6.0 mm ²
3 with neutral	5x1.5 mm ²

! **WARNING!**
The power cable must not touch the part of the appliance shaded in the illustration.

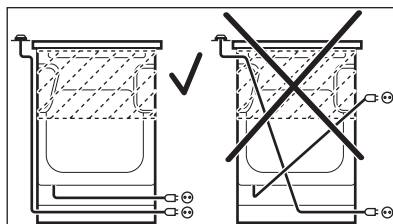

4. PRODUCT DESCRIPTION

4.1 General overview

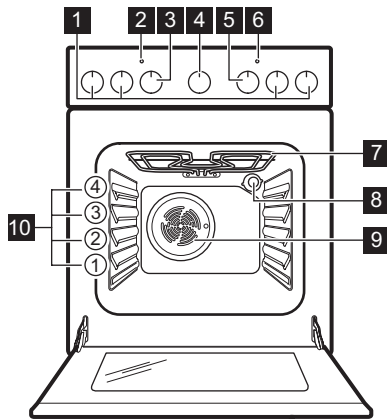

- 1** Knobs for the hob
- 2** Temperature indicator / symbol
- 3** Knob for the temperature
- 4** Knob for the Minute Minder
- 5** Knob for the oven functions
- 6** Hob lamp / symbol / indicator
- 7** Heating element
- 8** Lamp
- 9** Fan
- 10** Shelf positions

4.2 Cooking surface layout

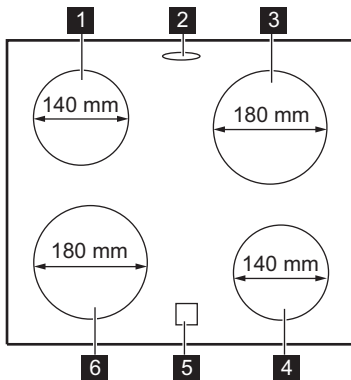

- 1** Cooking zone 1200 W
- 2** Steam outlet - number and position depend on the model
- 3** Cooking zone 1800 W
- 4** Cooking zone 1200 W
- 5** Residual heat indicator
- 6** Cooking zone 1800 W

4.3 Accessories

- **Wire shelf**
For cookware, cake tins, roasts.
- **Baking tray**

- For cakes and biscuits.
- **Storage drawer**
The storage drawer is below the oven cavity.

5. BEFORE FIRST USE



WARNING!
Refer to Safety chapters.



5.1 Initial Cleaning

Remove all accessories from the oven.
Refer to "Care and cleaning" chapter.

Clean the oven and the accessories before the first use.
Put the accessories back to their initial position.

5.2 Preheating

Preheat the empty oven before first use.

1. Set the function . Set the maximum temperature.
2. Let the oven operate for 1 hour.
3. Set the function . Set the maximum temperature. The maximum temperature for this function is 210 °C.
4. Let the oven operate for 15 minutes.
5. Turn off the oven and let it cool down.

Accessories can become hotter than usual. The oven can emit an odour and smoke. Make sure that the airflow in the room is sufficient.

5.3 Installing the steam outlet cover

1. Place the hooks of the cover under the front edge of the steam outlet holes.
2. Push down the back edge to lock the cover.

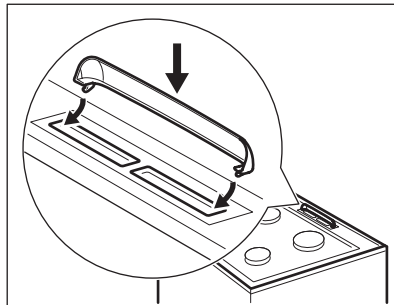

6. HOB - DAILY USE



WARNING!
Refer to Safety chapters.

6.1 Description of cooking zones

The cooking zones are fitted with thermostat and operate intermittently (goes off and on again) depending on the selected heat level.

6.2 Heat setting

Symbols	Function
0	Off position
	Keep warm
1 - 9	Heat settings



Use the residual heat to decrease energy consumption. Deactivate the cooking zone approximately 5 - 10 minutes before the cooking process is completed.

Turn the knob for the selected cooking zone to a necessary heat setting. The hob control indicator comes on. To complete the cooking process, turn the knob to the off position.

If all cooking zones are deactivated, the hob control indicator goes out.

6.3 Using the simple cooking zone

To use a simple cooking zone, turn the appropriate knob to one of the following positions: 1-9.



For heat settings 1-3, the zone remains red for about 2-3 seconds and then deactivates.

-  The zone operates at its maximum power level once you set the heat level to 8 or 9.

6.4 Residual heat indicator

-  **WARNING!**
There is a risk of burns from residual heat.

7. HOB - HINTS AND TIPS

-  **WARNING!**
Refer to Safety chapters.

7.1 Cookware

The cooking results depend on the cookware material

- **recommended:** aluminium, copper
- **not recommended:** stainless steel, cast iron, glass

-  The bottom of the cookware must be as thick and flat as possible. Ensure pan bases are clean and dry before placing on the hob surface.

-  Do not use cookware on the ceramic hob with bases with pronounced edges or ridges, e.g. cast iron pans. These could scratch or scour the hob surface permanently.

-  Cookware made of enamelled steel and with aluminium or copper bottoms can cause a colour change on the glass-ceramic surface.

The indicator comes on when a cooking zone is hot, but it does not function if mains power is disconnected.

To save energy and ensure that the hob operates properly the cookware bottom must have a suitable minimum diameter (at least the same as the zone diameter).

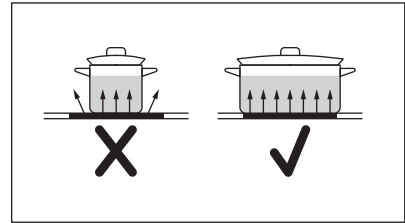

7.2 Examples of cooking applications

-  The data in the table is for guidance only.

Heat setting	Use to:	Time (min)	Hints
 - 1	Keep cooked food warm.	as necessary	Put a lid on the cookware.

Heat setting	Use to:	Time (min)	Hints
1 - 2	Hollandaise sauce, melt: butter, chocolate, gelatine.	5 - 25	Mix from time to time.
1 - 2	Solidify: fluffy omelettes, baked eggs.	10 - 40	Cook with a lid on.
2 - 3	Simmer rice and milkbased dishes, heat up ready-cooked meals.	25 - 50	Add at least twice as much liquid as rice, mix milk dishes halfway through the procedure.
3 - 4	Steam vegetables, fish, meat.	20 - 45	Add a couple of tablespoons of liquid.
4 - 5	Steam potatoes.	20 - 60	Use max. ¼ l of water for 750 g of potatoes.
4 - 5	Cook larger quantities of food, stews and soups.	60 - 150	Up to 3 l of liquid plus ingredients.
6 - 7	Gentle fry: escalope, veal cordon bleu, cutlets, rissoles, sausages, liver, roux, eggs, pancakes, doughnuts.	as necessary	Turn halfway through.
7 - 8	Heavy fry, hash browns, loin steaks, steaks.	5 - 15	Turn halfway through.
9	Boil water, cook pasta, sear meat (goulash, pot roast), deep-fry chips.		

8. HOB - CARE AND CLEANING



WARNING!

Refer to Safety chapters.

8.1 General information

- Clean the hob after each use.
- Always use cookware with a clean base.
- Scratches or dark stains on the surface have no effect on how the hob operates.
- Use a special cleaner suitable for the surface of the hob.
- Use a special scraper for the glass.

8.2 Cleaning the hob

- **Remove immediately:** melted plastic, plastic foil, sugar and food with sugar,

otherwise, the dirt can cause damage to the hob. Take care to avoid burns.

Use a special hob scraper on the glass surface at an acute angle and move the blade on the surface.

- **Remove when the hob is sufficiently cool:** limescale rings, water rings, fat stains, shiny metallic discoloration. Clean the hob with a moist cloth and a non-abrasive detergent. After cleaning, wipe the hob dry with a soft cloth.
- **Remove shiny metallic discoloration:** use a mixture of baking powder and lemon juice or vinegar.

9. OVEN - DAILY USE



WARNING!
Refer to Safety chapters.

9.1 Turning the oven on and off

1. Turn the knob for the oven functions to select an oven function.
2. Turn the knob for the temperature to select the temperature.





The lamp turns on when the oven operates.

3. To turn off the oven, turn the knobs for the oven functions and temperature to the off position.

9.2 Safety thermostat

Incorrect operation of the oven or defective components can cause dangerous overheating. To prevent this, the oven has a safety thermostat which interrupts the power supply. The oven turns on again automatically when the temperature drops.

9.3 Oven functions

Sym- bol	Oven function	Application
0	Off position	The oven is off.
	Conventional Cooking	To bake and roast food on one shelf position.
	Grilling	To grill flat food and to toast bread The maximum temperature for this function is 210 °C.
	Bottom Heat	To bake cakes with crispy bottom and to preserve food.
	Fan Cooking	To roast or roast and bake food with the same cooking temperature on more than one shelf position, without flavour transference.
	Defrost	To defrost food (vegetables and fruit). The defrosting time depends on the amount and size of the frozen food. To use this function, the knob for the temperature must be in the off position.

Symbol	Oven function	Application
	Moist Baking	This function is designed to save energy during cooking. For the cooking instructions refer to "Hints and tips" chapter, Moist Baking. The oven door should be closed during cooking so that the function is not interrupted and to ensure that the oven operates with the highest energy efficiency possible. When you use this function, the temperature in the cavity may differ from the set temperature. The heating power may be reduced. For general energy saving recommendations refer to "Energy Efficiency" chapter, Oven - Energy Saving. This function was used to comply with the energy efficiency class according to EN 60350-1.

10. OVEN - CLOCK FUNCTIONS

10.1 Minute Minder

Use it to set a countdown time.

 This function has no effect on the operation of the appliance.

1. Set an oven function and the temperature.

2. Turn the knob for the timer as far as it goes, then turn it to necessary time period.

After the time period is completed, an acoustic signal sounds.

11. OVEN - USING THE ACCESSORIES

 **WARNING!**
Refer to Safety chapters.

11.1 Inserting the accessories

Wire shelf:

 The wire shelf has a special shape in the rear which helps with the heat circulation.

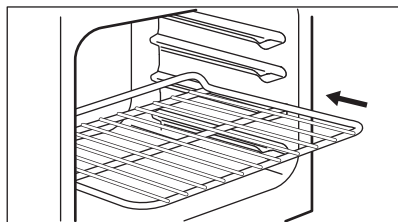

Put the shelf on the correct shelf position. Make sure it does not touch the back wall of the oven.

Tray:

 Do not push the baking tray all the way to the back wall of the cavity. This prevents the heat from circulating around the tray. The food may be burnt, especially in the rear part of the tray.

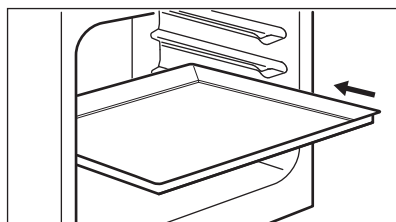

Put the tray or deep pan on the shelf position. Make sure it does not touch the back wall of the oven.

12. OVEN - HINTS AND TIPS



WARNING!
Refer to Safety chapters.



The temperature and baking times in the tables are guidelines only. They depend on the recipes and the quality and quantity of the ingredients used.

12.1 General information

The appliance has four shelf positions. Count the shelf positions from the bottom of the appliance floor.

The appliance has a special system which circulates the air and constantly recycles the steam. With this system you can cook in a steamy environment and keep the food soft inside and crusty outside. It decreases the cooking time and energy consumption to a minimum.

Moisture can condense in the appliance or on the door glass panels. This is normal. Always stand back from the appliance when you open the appliance door while cooking. To decrease the condensation, operate the appliance for 10 minutes before cooking.

Clean the moisture after each use of the appliance.

Do not put the objects directly on the appliance floor and do not put aluminium foil on the components when you cook. This can change the baking results and cause damage to the enamel.

12.2 Baking

For the first baking, use the lower temperature.

You can extend the baking time by 10 – 15 minutes if you bake cakes on more than one shelf position.

Cakes and pastries at different heights do not always brown equally. There is no need to change the temperature setting if an unequal browning occurs. The differences equalize during baking.

Trays in the oven can distort during baking. When the trays are cold again, the distortions disappear.

12.3 Baking cakes

Do not open the oven door before 3/4 of the set cooking time is up.

If you use two baking trays at the same time, keep one empty level between them.

12.4 Cooking meat and fish

Leave the meat for approximately 15 minutes before carving so that the juice does not seep out.

To prevent too much smoke in the oven during roasting, add some water into the deep pan. To prevent the smoke condensation, add water each time after it dries up.

12.5 Cooking times

Cooking times depend on the type of food, its consistency, and volume.

Initially, monitor the performance when you cook. Find the best settings (heat setting, cooking time, etc.) for your cookware, recipes and quantities when you use this appliance.

12.6 Conventional Cooking

Food	Quantity (g)	Temperature (°C)	Time (min)	Shelf position	Accessories
Flat cake ¹⁾	1000	160 - 170	30 - 35	2	baking tray
Yeast cake with apples	2000	170 - 190	40 - 50	3	baking tray
Drip pan cake	1500	160 - 170	45 - 55 ²⁾	2	baking tray
Chicken, whole	1350	200 - 220	60 - 70	2	wire shelf
				1	baking tray
Chicken, half	1300	190 - 210	35 + 30	3	wire shelf
				1	baking tray
Flan bread ³⁾	800	230 - 250	10 - 15	2	baking tray
Stuffed yeast cake ⁴⁾	1200	170 - 180	25 - 35	2	baking tray
Pizza	1000	200 - 220	25 - 35	2	baking tray
Cheese cake	2600	170 - 190	60 - 70	2	baking tray
Swiss apple flan ⁴⁾	1900	200 - 220	30 - 40	1	baking tray
Christmas cake ⁴⁾	2400	170 - 180	55 - 65 ⁵⁾	2	baking tray
Quiche Lor-raine ⁴⁾	1000	220 - 230	40 - 50	1	1 round tray (diameter: 26 cm)
Peasant bread ⁶⁾	750 + 750	180 - 200	60 - 70	1	2 light trays (length: 20 cm)
Romanian sponge cake ¹⁾	600 + 600	160 - 170	40 - 50	2	2 light trays (length: 25 cm) on the same shelf position
Romanian sponge cake - traditional	600 + 600	160 - 170	30 - 40	2	2 light trays (length: 25 cm) on the same shelf position
Yeast buns ⁴⁾	800	200 - 210	10 - 15	2	baking tray
Swiss roll ¹⁾	500	150 - 170	15 - 20	1	baking tray
Meringue	400	100 - 120	40 - 50	2	baking tray

Food	Quantity (g)	Temperature (°C)	Time (min)	Shelf position	Accessories
Crumble cake ⁴⁾	1500	180 - 190	25 - 35	3	baking tray
Buttered cake ¹⁾	600	180 - 200	20 - 25	2	baking tray

1) Preheat the oven for 10 minutes.

2) After you switch off the appliance, leave the cake in the oven for 7 minutes.

3) Preheat the oven for 20 minutes.

4) Preheat the oven for 10 - 15 minutes.

5) After you switch off the appliance, leave the cake in the oven for 10 minutes.

6) Set the temperature for 250 °C and preheat the oven for 18 minutes.

12.7 Fan Cooking

Food	Quantity (g)	Temperature (°C)	Time (min)	Shelf position	Accessories
Flat cake ¹⁾	1000	150	30	2	baking tray
Flat cake ¹⁾	1000 + 1000	155	40	1 + 3	baking tray
Yeast cake with apples	2000	170 - 180	40 - 50	3	baking tray
Drip pan cake	1200	150 - 160	30 - 35 ²⁾	2	baking tray
Chicken, whole	1400	180	55	2	wire shelf
				1	baking tray
Stuffed yeast cake	1200	150 - 160	20 - 30	2	baking tray
Pizza	1000 + 1000	200 - 210	30 - 40	1 + 3	baking tray
Pizza	1000	190 - 200	25 - 35	2	baking tray
Cheese cake	2600	160 - 170	40 - 50	1	baking tray
Swiss apple flan ³⁾	1900	180 - 200	30 - 40	2	baking tray
Christmas cake ³⁾	2400	150 - 160	35 - 40 ²⁾	2	baking tray
Quiche Lorraine ³⁾	1000	190 - 210	30 - 40	1	1 round tray (diameter: 26 cm)

Food	Quantity (g)	Temperature (°C)	Time (min)	Shelf position	Accessories
Peasant bread ⁴⁾	750 + 750	160 - 170	40 - 50	1	baking tray
Romanian sponge cake ³⁾	600 + 600	155 - 165	40 - 50	2	2 light trays (length: 25 cm) on the same shelf position
Romanian sponge cake - traditional	600 + 600	150 - 160	30 - 40	2	2 light trays (length: 25 cm) on the same shelf position
Yeast buns ¹⁾	800	190	15	3	baking tray
Yeast buns ⁵⁾	800 + 800	190	15	1 + 3	baking tray
Swiss roll ¹⁾	500	150 - 160	15 - 20	3	baking tray
Meringue	400	110 - 120	30 - 40	2	baking tray
Meringue	400 + 400	110 - 120	45 - 55	1 + 3	baking tray
Crumble cake	1500	160 - 170	25 - 35	3	baking tray
Sponge cake ¹⁾	600	150 - 160	25 - 35	2	baking tray
Buttered cake ¹⁾	600 + 600	160 - 170	25 - 35	1 + 3	baking tray

1) Preheat the oven for 10 minutes.

2) After you switch off the appliance, leave the cake in the oven for 7 minutes.

3) Preheat the oven for 10 - 15 minutes.

4) Set the temperature for 250 °C and preheat the oven for 10 - 20 minutes.

5) Preheat the oven for 15 minutes.

12.8 Moist Baking

Food	Temperature (°C)	Time (min)	Shelf position	Accessories
Bread and pizza				
Buns	190	25 - 30	2	baking tray or grill- / roasting pan
Bread rolls	200	40 - 45	2	baking tray or grill- / roasting pan

Food	Temperature (°C)	Time (min)	Shelf position	Accessories
Frozen pizza 350 g	190	25 - 35	2	wire shelf
Cakes in baking tray				
Swiss roll	180	20 - 30	2	baking tray or grill- / roasting pan
Brownie	180	35 - 45	2	baking tray or grill- / roasting pan
Cakes in tin				
Soufflé	210	35 - 45	2	six ceramic ramekins on wire shelf
Sponge flan base	180	25 - 35	2	flan base tin on wire shelf
Sponge cake	150	35 - 45	2	cake tin on wire shelf
Fish				
Fish in pouches 300 g	180	25 - 35	2	baking tray or grill- / roasting pan
Whole fish 200 g	180	25 - 35	2	baking tray or grill- / roasting pan
Fish fillet 300 g	180	30 - 40	2	pizza pan on wire shelf
Meat				
Meat in pouch 250 g	200	35 - 45	2	baking tray or grill- / roasting pan
Meat skewers 500 g	200	30 - 40	2	baking tray or grill- / roasting pan
Small baked items				
Cookies	170	25 - 35	2	baking tray or grill- / roasting pan
Macarons	170	40 - 50	2	baking tray or grill- / roasting pan
Muffins	180	30 - 40	2	baking tray or grill- / roasting pan
Savoury cracker	160	25 - 35	2	baking tray or grill- / roasting pan
Shortcrust pastry biscuits	140	25 - 35	2	baking tray or grill- / roasting pan
Tartelettes	170	20 - 30	2	baking tray or grill- / roasting pan

Food	Temperature (°C)	Time (min)	Shelf position	Accessories
Vegetarian				
Mixed vegetables in pouch 400 g	200	20 - 30	2	baking tray or grill- / roasting pan
Omelette	200	30 - 40	2	pizza pan on wire shelf
Vegetables on tray 700 g	190	25 - 35	2	baking tray or grill- / roasting pan

12.9 Information for test institutes

Food	Function	Temperature (°C)	Accessories	Shelf position	Time (min)
Small cakes (16 per tray)	Conventional Cooking	160	baking tray	3	20 - 30
Small cakes (16 per tray)	Fan Cooking	150	baking tray	3	20 - 30
Apple pie (2 tins Ø20 cm, diagonally off set)	Conventional Cooking	190	wire shelf	1	65 - 75
Apple pie (2 tins Ø20 cm, diagonally off set)	Fan Cooking	180	wire shelf	2	70 - 80
Fatless sponge cake	Conventional Cooking	180	wire shelf	2	20 - 30
Fatless sponge cake	Fan Cooking	160	wire shelf	2	25 - 35
Short bread / Pastry stripes	Conventional Cooking	140	baking tray	3	15 - 30
Short bread / Pastry stripes	Fan Cooking	140	baking tray	3	20 - 30
Toast ¹⁾	Grilling	max	wire shelf	2	2 - 5
Beef burger ²⁾	Grilling	max	wire shelf	3	15 - 20 first side; 15 - 20 second side

¹⁾ Preheat the oven for 5 minutes.

²⁾ Preheat the oven for 10 minutes.

13. OVEN - CARE AND CLEANING



WARNING!
Refer to Safety chapters.

13.1 Notes on cleaning

Clean the front of the oven with a soft cloth with warm water and a mild cleaning agent.

To clean metal surfaces, use a dedicated cleaning agent.

Clean the oven interior after each use. Fat accumulation or other food remains may result in a fire.

Clean all accessories after each use and let them dry. Use a soft cloth with warm water and a cleaning agent. Do not clean the accessories in the dishwasher.

Clean stubborn stains with a special oven cleaner.

Do not clean the non-stick accessories using abrasive cleaner or sharp-edged objects.

13.2 Stainless steel or aluminium ovens

Clean the oven door with a damp cloth or sponge only. Dry it with a soft cloth.

Do not use steel wool, acids or abrasive materials as they can damage the oven surface. Clean the oven control panel with the same precautions.

13.3 Cleaning the oven door

The oven door has two glass panels. You can remove the oven door and the internal glass panel to clean it.



The oven door may close if you try to remove the internal glass panel before you remove the oven door.



CAUTION!
Do not use the appliance without the internal glass panel.

1. Open the door fully and hold both hinges.

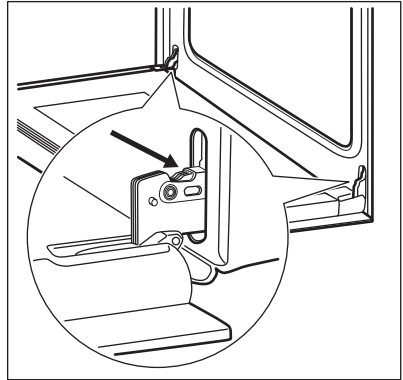

2. Lift and turn the levers fully on both hinges.

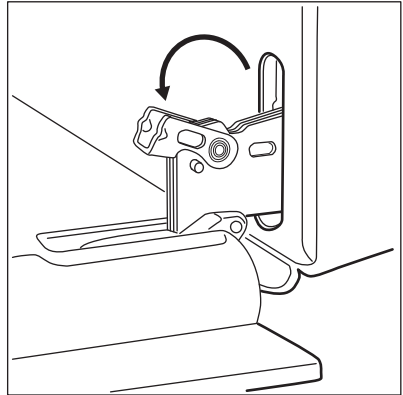

3. Close the oven door halfway to the first opening position. Then lift and pull forward and remove the door from its seat.

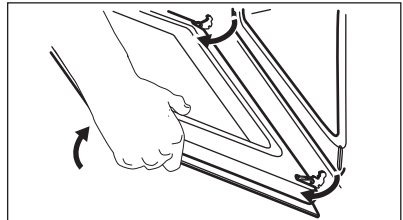

4. Put the door on a soft cloth on a stable surface.

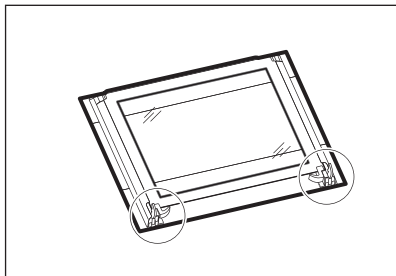

5. Release the locking system to remove the internal glass panel.

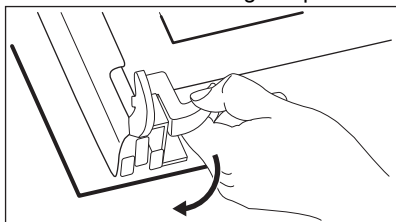

6. Turn the two fasteners by 90° and remove them from their seats.

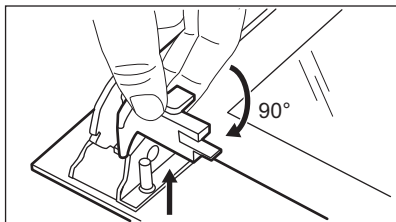

7. First lift carefully and then remove the glass panel.

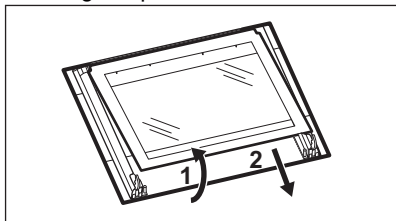

8. Clean the glass panels with water and soap. Dry the glass panels carefully. Do not clean the glass panels in the dishwasher.

When the cleaning is completed, install the glass panel and the oven door. Do the above steps in the opposite sequence.

Make sure that you install the internal glass panel in the seats correctly.

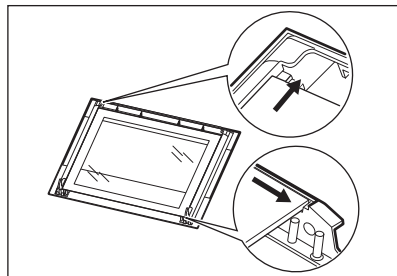

13.4 Removing the drawer



WARNING!

Do not keep flammable items (such as cleaning materials, plastic bags, oven gloves, paper or cleaning sprays) in the drawer. When you use the oven, the drawer can become hot. There is a risk of fire.

The drawer below the oven can be removed for cleaning.

1. Pull the drawer out until it stops.

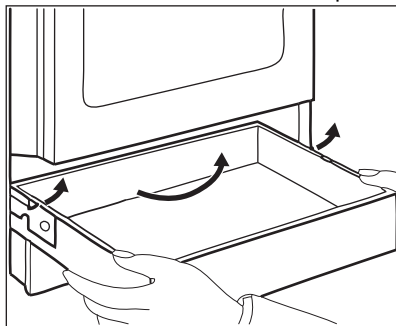

2. Slowly lift the drawer.
3. Pull the drawer out fully.

To install the drawer, do the above steps in the opposite sequence.

13.5 Replacing the lamp



WARNING!

Risk of electric shock.
The lamp can be hot.

1. Turn off the oven. Wait until the oven is cold.
2. Disconnect the oven from the mains.

- Put a cloth on the bottom of the cavity.

The back lamp

- Turn the lamp glass cover to remove it.

- Clean the glass cover.
- Replace the lamp with a suitable 300 °C heat-resistant lamp.
- Install the glass cover.

14. TROUBLESHOOTING



WARNING!
Refer to Safety chapters.

14.1 What to do if...

Problem	Possible cause	Remedy
You cannot activate the appliance.	The appliance is not connected to an electrical supply or it is connected incorrectly.	Check if the appliance is correctly connected to the electrical supply.
	The fuse is blown.	Make sure that the fuse is the cause of the malfunction. If the fuse is blown again and again, contact a qualified electrician.
You cannot activate or operate the hob.	The fuse is blown.	Activate the hob again and set the heat setting in less than 10 seconds.
Residual heat indicator does not come on.	The zone is not hot because it operated only for a short time.	If the zone operated sufficiently long to be hot, speak to an Authorised Service Centre.
The oven does not heat up.	The oven is deactivated.	Activate the oven.
	The necessary settings are not set.	Make sure that the settings are correct.
The lamp does not operate.	The lamp is defective.	Replace the lamp.
Steam and condensation settle on the food and in the cavity of the oven.	You left the dish in the oven for too long.	Do not leave the dishes in the oven for longer than 15 - 20 minutes after the cooking process ends.
It takes too long to cook the dishes or they cook too quickly.	The temperature is too low or too high.	Adjust the temperature if necessary. Follow the advice in the user manual.

14.2 Service data

If you cannot find a solution to the problem yourself, contact your dealer or an Authorised Service Centre.

The necessary data for the service centre is on the rating plate. The rating

plate is on the front frame of the oven cavity. Do not remove the rating plate from the oven cavity.

We recommend that you write the data here:	
Model (MOD.)
Product number (PNC)
Serial number (S.N.)

15. ENERGY EFFICIENCY

15.1 Product information for hob according to EU 66/2014

Model identification	LKR620002W LKR620002X	
Type of hob	Hob inside Freestanding Cooker	
Number of cooking zones	4	
Heating technology	Radiant Heater	
Diameter of circular cooking zones (Ø)	Left rear	14.0 cm
	Right rear	18.0 cm
	Right front	14.0 cm
	Left front	18.0 cm
Energy consumption per cooking zone (EC electric cooking)	Left rear	181.8 Wh/kg
	Right rear	182.1 Wh/kg
	Right front	181.8 Wh/kg
	Left front	182.1 Wh/kg
Energy consumption of the hob (EC electric hob)	182.0 Wh/kg	

EN 60350-2 - Household electric cooking appliances - Part 2: Hobs - Methods for measuring performance.

15.2 Hob - Energy saving

You can save energy during everyday cooking if you follow below hints.

- When you heat up water, use only the amount you need.
- If it is possible, always put the lids on the cookware.
- Before you activate the cooking zone put the cookware on it.
- The cookware bottom should have the same diameter as the cooking zone.
- Put the smaller cookware on the smaller cooking zones.
- Put the cookware directly in the centre of the cooking zone.
- Use the residual heat to keep the food warm or to melt it.

15.3 Product information for ovens and Product Information Sheet*

Supplier's name	Electrolux	
Model identification	LKR620002W 943005286 LKR620002X 943005287	
Energy Efficiency Index	94.9	
Energy efficiency class	A	
Energy consumption with a standard load, conventional mode	0.84 kWh/cycle	
Energy consumption with a standard load, fan-forced mode	0.74 kWh/cycle	
Number of cavities	1	
Heat source	Electricity	
Volume	54 l	
Type of oven	Oven inside Freestanding Cooker	
Mass	LKR620002W	42.0 kg
	LKR620002X	41.0 kg

* For European Union according to EU Regulations 65/2014 and 66/2014.
For Republic of Belarus according to STB 2478-2017, Appendix G; STB 2477-2017, Annexes A and B.
For Ukraine according to 568/32020.

Energy efficiency class is not applicable for Russia.

EN 60350-1 - Household electric cooking appliances - Part 1: Ranges, ovens, steam ovens and grills - Methods for measuring performance.

15.4 Oven - Energy saving



The oven has features which help you save energy during everyday cooking.

Make sure that the oven door is closed when the oven operates. Do not open the oven door too often during cooking. Keep the door gasket clean and make sure it is well fixed in its position.

When possible, do not preheat the oven before cooking.

Keep breaks between baking as short as possible when you prepare a few dishes at one time.

Cooking with fan

When possible, use the cooking functions with fan to save energy.

Moist Baking

Function designed to save energy during cooking. For additional details refer to "Oven - Daily use" chapter, Oven functions.

16. SAUDI ARABIA - CUSTOMER SERVICE

Further after-sales service agencies overseas

In these countries our respective agents' own guarantee conditions are applicable. Please obtain further details directly.

First Distribution Company (FDC) Al Faisaliah Group

Main service center address:

Al Khalidiya area – Port Street – Building name: Mussa 4

AL Dammam, Kingdom of Saudi Arabia.

Postal address:

P.O Box 2728 Riyadh 11461

Kingdom of Saudi Arabia

tel. + 966 11 243-9732

fax +966 11 243-9674

17. ENVIRONMENTAL CONCERNS

Recycle materials with the symbol .
Put the packaging in relevant containers to recycle it. Help protect the environment and human health by recycling waste of electrical and electronic appliances. Do not dispose of

appliances marked with the symbol  with the household waste. Return the product to your local recycling facility or contact your municipal office.

www.electrolux.com/shop



867 354 857 - C - 392021

